

DBC-1200 USER GUIDE



technetix

Online

Email: customer.service.vdl@technetix.com

Website: technetix.com

Safety	1
Intended audience.....	1
Specific tools list.....	1
Software.....	2
Installing the BLA software on a phone or tablet.....	2
Modules available for the DBC-1200	3
Chapter 1: Overview of the DBC-1200.....	4
Chapter 2: RF amplifier.....	5
Chapter 3: Installing the DBC-1200	6
3.1 Housing mounting.....	6
3.1.1 Using side brackets.....	6
3.1.2 Rear mounting direct to cabinet back panel	7
3.2 Installing coaxial.....	8
3.3 Closing amplifier	9
3.4 Configuring the PSU	10
3.5 Powering up the amplifier.....	11
3.6 Downstream configuration	13
3.7 Downstream activation.....	14
3.8 Upstream activation	21
Chapter 4: Maintenance	25
4.1 PSU replacement.....	25
4.2 Amplifier module replacement.....	27
Chapter 5: Optical node 1x1	30
5.1 General installation.....	30
5.2 Downstream connection.....	30
5.3 Upstream connection.....	31
5.4 CWDM applications.....	32
5.5 Software settings.....	32
5.6 Upgrading a RF amplifier into an optical node.....	33
5.7 Optical modules	35



Safety



Caution: AC voltages in the range of 20 – 90 VAC (110/230 VAC local power) can be present when power is connected to the DBC-1200. Observe all notes and cautions in this user guide.

Intended audience

The DBC-1200 User Guide is intended for network engineers and technicians responsible for planning, configuring, installing and testing the Technetix DBC-1200 amplifier. Installers should have a working knowledge of coaxial cable systems and cabling practices.

Specific tools list

The following tools and supplies are required when installing a DBC-1200:

- 6mm hex key for the lid bolts
- Set of crosshead screwdrivers
- Pair of linesman's pliers (only needed if changing the diplex filters)
- Torque wrench
- Appropriate bolts/screws/washers for mounting the DBC-1200 (see page 7)
- Appropriate USB for the:
 - DBDCM-A-1 FSK module (for local control/ALSC)
 - DBDCM-B-2 DOCSIS control module (DOCSIS cabling is included in transponder set)
 - T-box (for bluetooth/Wi-Fi communication)

The connector on the other side of the cable will depend on the device you are using.

Software

The software required to configure a DBC-1200 depends on the device being used to connect to the modules within the amplifier:

- Laptop – BLL software. Requires Windows OS.
- Android – BLA software. Android version 4.1 or higher and USB host.

Note: We refer to BLL software and a laptop in this user guide but also apply when using an Android device with BLA.

Installing the BLA software on a phone or tablet

1. Ensure the device will allow unknown sources:
 - a. Go to Applications > Settings > Applications
 - b. Select - Unknown sources
2. Copy the BLA vx.x.apk file to the device:
 - a. Go to Applications > Settings > Wireless and Network > USB Settings
 - b. Select Mass storage
 - c. Connect the phone/tablet to your PC
 - d. The drives of the phone will appear in file explorer
 - e. Copy the .apk file to a suitable place on the phone/tablet
3. Go to applications > my files
4. Browse to the .apk file
5. Click the BLA .apk file
6. Select 'OK' to install
7. Once installed you can select 'open' or 'done'
8. The Technetix BLA shortcut can now be found with all the other applications on your device.

USB flyleads:

19005966	USB MICRO OTG (10cm – Mini USB)
19005965	USB A-male to B-mini 2M
19010840	USB A-male to A-male 5M
19007113	USB A-male to B-mini 5M



Modules available for the DBC-1200

Upstream (US)

DBUS-A-1	Main module: 105MHz US amplifier 25dB gain and IDS
DBUS-C-1	Main module: 204MHz US amplifier 26dB gain and IDS

Downstream (DS)

DBDS-B-4-1	Main: 1.2GHz DS amplifier 44dB - 49dbmV output
DBDS-B-4-ET	Main: 1.2GHz DS amplifier 44dB - 49dbmV output - ET.25dB tilt
DBDS-B-5-1	Main: 1.2GHz DS amplifier 38dB - 49dbmV output
DBDS-B-6-1	Main: 1.2GHz DS amplifier 32dB - 49dbmV output
DBDS-B-7-1	Main: 1.2GHz DS amplifier 44dB - 53dbmV output
DBDS-B-7-ET	Main: 1.2GHz DS amplifier 44dB - 53dbmV output ET.25dB tilt

Control module

DBDCM-A-1	AGC/ALSC, FSK, USB-A (mini USB)
DBDCM-B-2	AGC/ALSC, DOCSIS transponder compatible (USB-A)
DBDDM-A-1	DOCSIS 3.0 Transponder (RS232 & MCX)
DBDDM-B-1	EuroDOCSIS 3.0 Transponder

Diplexer

DBDIP-xx	A range of diplex filters where: xx= 01: 65/85 MHz xx= 02: 85/102 MHz xx= 03: 204/258 MHz xx= 04: 42/54 MHz xx= 05: 85/105 MHz
----------	---

Power

DBPSU-04	Power supply available for line powering (nominal 65 VAC) 20-65V.
DBPSU-05	230 VAC power supply for local powering.

Chapter 1: Overview of the DBC-1200

The Technetix DBC-1200 amplifier is an innovative ‘crossover’ design which provides a field upgradeable solution to deep fibre/fibre to the last amplifier (FttLA). Its RF function can be configured for use as single, dual or triple output device (with or without an internal splitter/directional coupler).

The amplifier provides reverse path transmission with a hybrid amplification stage.

Forward and return path attenuation can be adjusted with electronic attenuators. Electronic equalisers are available for forward and return path equalisation. Cable simulation is provided by a JXP module.

The DBC-1200 has a highly efficient, long-life, switch-mode power supply to provide the power.

Gas tubes at the input and output ports protect the RF circuits in the event of lightning or mains power surges.

Benefits:

- Full digital control and setup with integrated ALSC
- Improved intermodulation distortion performance - innovative GaN technology operates to 1218 MHz
- Energy efficient hybrid technology provides more gain from the same power consumption
- Flexible and modular to meet changing network needs
- Technetix CPD Safe® technology and surge protection mean fewer reported faults, improved customer service and a reduction in truck rolls
- On-board ingress detection facility provides an option to apply -6 dB or -40 dB of return path attenuation via a simple transponderless protocol (FSK).

Chapter 2: RF amplifier

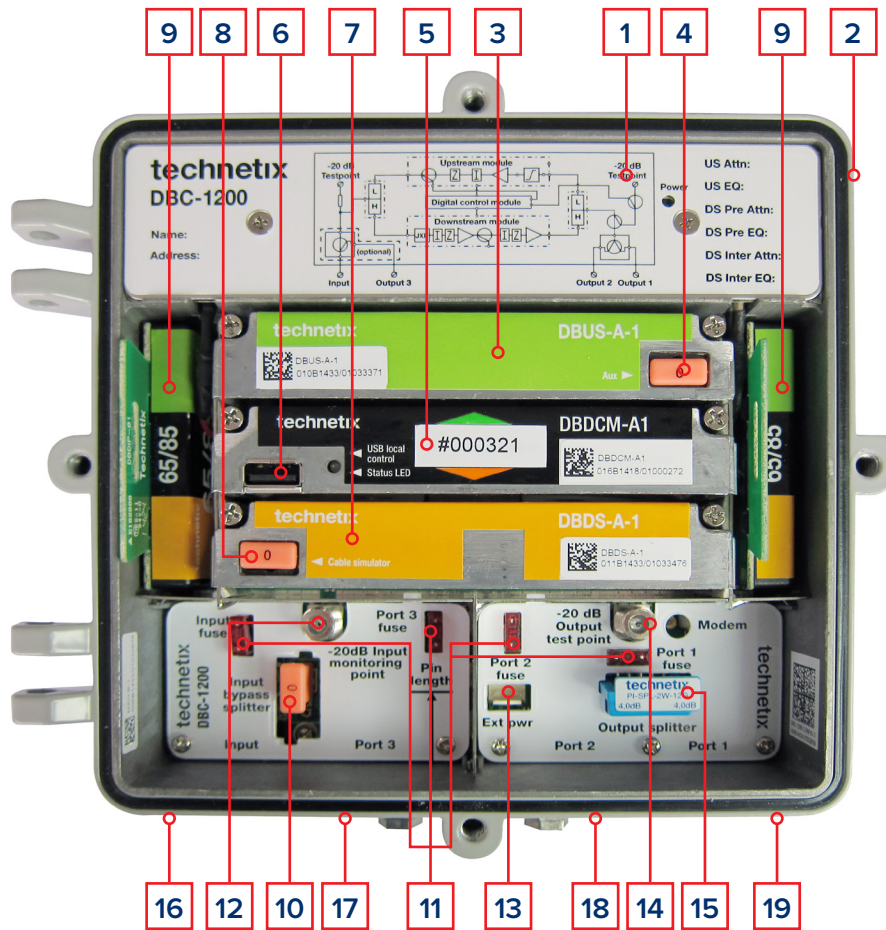

1. Removable power supply under cover plate
2. Optional local powering port (mains or 65 VAC)
3. Upstream amplifier module
4. Upstream auxiliary plug-in JXP attenuator location
5. Digital control module
6. Digital control module USB connection
7. Downstream amplifier module
8. Downstream cable simulator JXP location (can be used for other types of JXP plug-in)
9. Input and output diplex filters.42/54, 65/85, 85/102, 85/105 and 204/258 options
10. Input bypass splitter location: 2-way splitter PI-SPL-2W-12G; directional coupler tap 8dB TX DC-8; tap 12 dB TX DC-12
11. Port power directors/fuses (micro2 automotive)
12. Input -20 dB test point (omnidirectional)
13. External bypass power for power continuity during maintenance
14. Output downstream -20 dB test point (upstream injection -20 dB test point)
15. Output splitter location: 2-way splitter PI-SPL-2W-12G; directional coupler tap 8dB TX DC-8; tap 12dB TX DC-12
16. Input RF port - PG11 thread with optional 5/8" reducing ring for 5/8" threaded connectors
17. Port 3 RF output port- PG11 thread with optional 5/8" reducing ring for 5/8" threaded connectors
18. Port 2 RF output port- PG11 thread with optional 5/8" reducing ring for 5/8" threaded connectors
19. Port 1 RF output port- PG11 thread with optional 5/8" reducing ring for 5/8" threaded connectors

Chapter 3: Installing the DBC-1200

3.1 Housing mounting

There are two options for mounting the DBC-1200 amplifier:

3.1.1 Using side brackets

The unit is supplied with 2 x 'L' brackets that are attached onto the side of the unit using the 2 x 6mm threaded 10mm long countersunk screws provided (see the pictures below). Once the brackets are attached, the amplifier can be offered up to the mounting location to mark the bracket cut outs onto the mounting surface ready for holes to be made for the mounting bolts/screws. The amplifier can then be attached to the mounting surface using appropriate fixing devices.

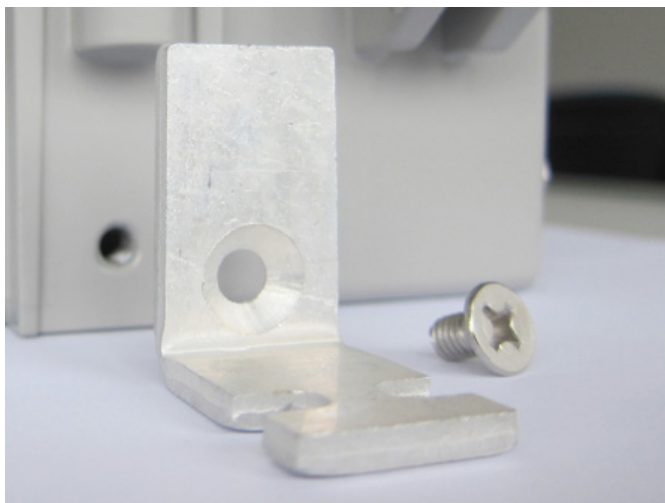



3.1.2 Rear mounting direct to cabinet back panel

For mounting directly onto a cabinet back panel, use the rear 6mm bolt holes with 2 x 6mm threaded bolts (figure 1). Do not use fixings that are longer than 6mm, otherwise they may protrude through the back board. The bolt total length dimension to be used is 6mm + back board thickness dimension + washer thickness dimension.

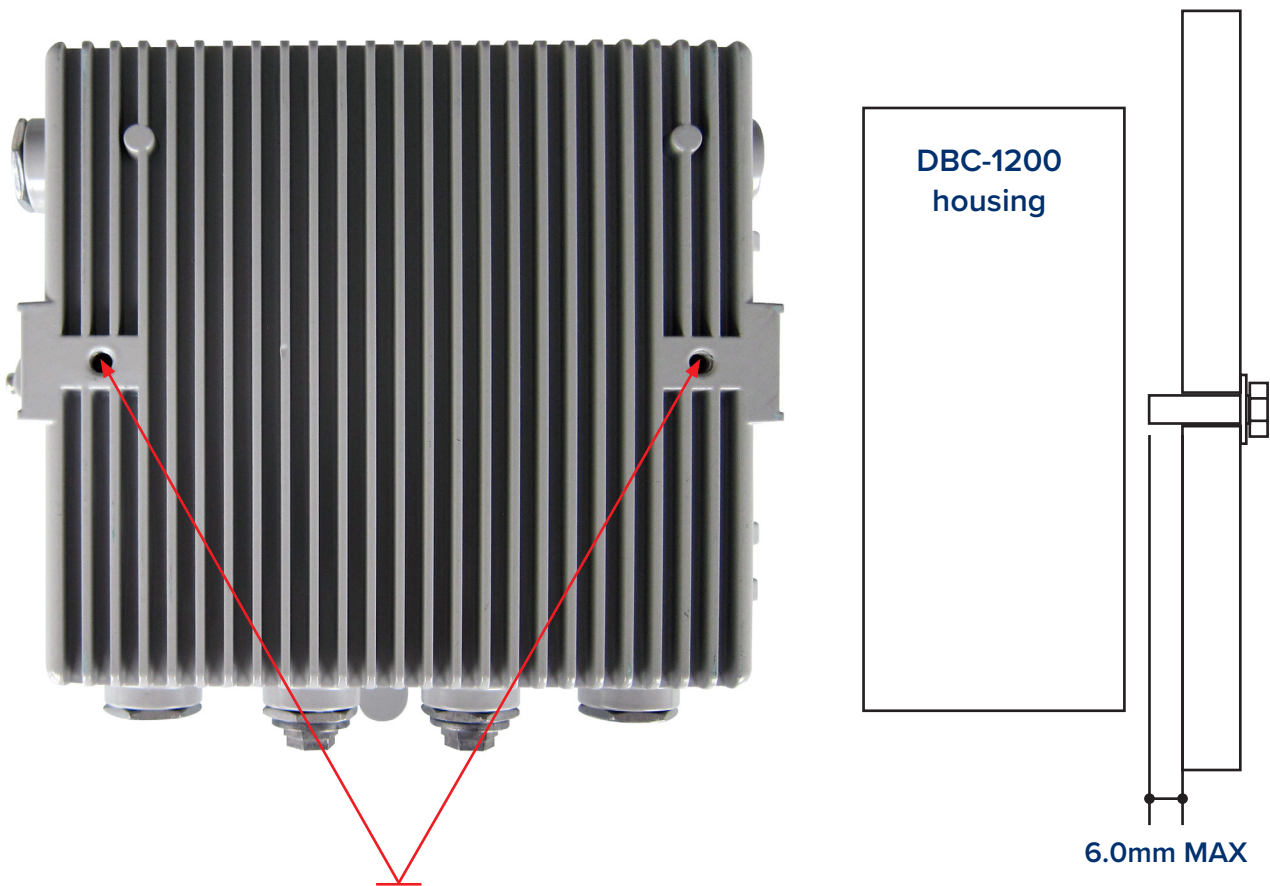

Housing 6mm threaded bolt holes @140mm centres
(Figure 1)

3.2 Installing coaxial

1. Cut the connector pins to a length of 28mm for PG11 threaded connectors (figure 2). When using 5/8" threaded connectors and PG11 to 5/8" reducing rings, add 2.5mm to the connector pin length = 30.5mm.

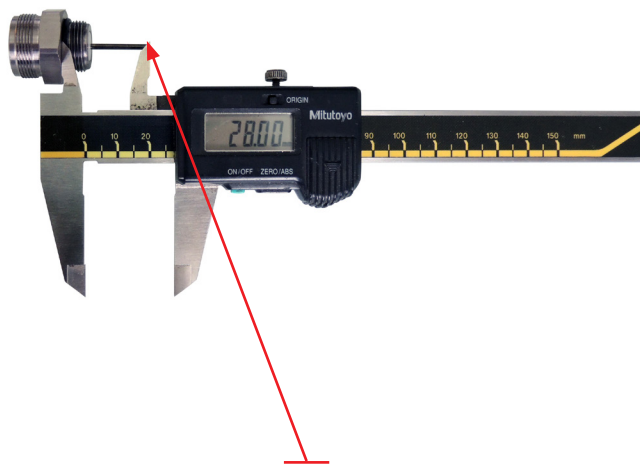

PG11 connector: pin length from connector housing shoulder to pin tip = 28mm (Figure 2)

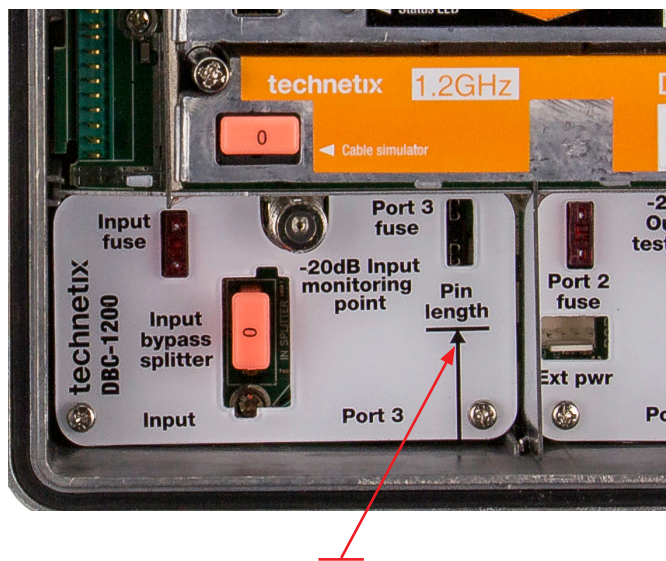

Use the internal pin length guide to check the correct pin length. Place the PG11 connector housing shoulder against the amplifier housing lip to check the pin length.

2. Tighten the connectors into the housing in accordance with the connector manufacturer's specification. The maximum torque force for the PG-11_5/8 adapter ring is 20 Nm.

3.3 Closing amplifier

Use a 6mm hex key to tighten the four lid securing bolts.

Next, using a 10mm socket, hand tighten the lid bolts in the following sequence: 1 - right hand bolt; 2 - left hand bolt; 3 - bottom bolt; 4 - top bolt. Then, using a torque wrench set to a torque value of 5 Nm, go round again in sequence and tighten to the final torque setting.

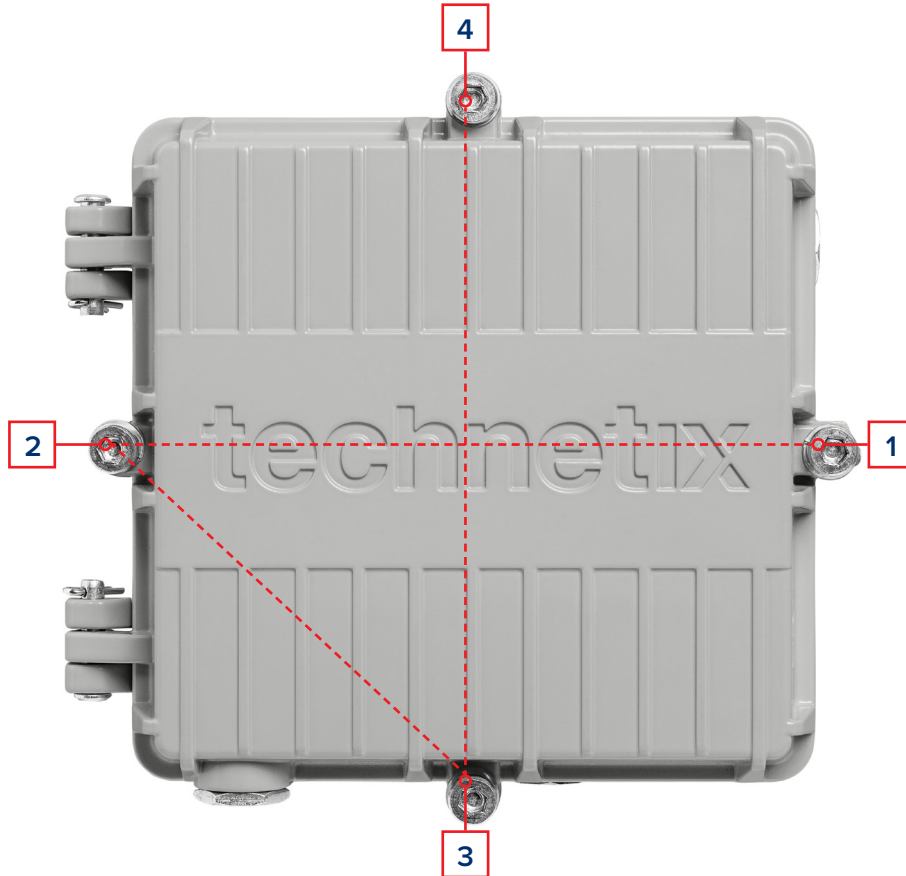

Following this sequence will ensure:

1. The rubber gasket between the lid and the amplifier housing is sealed correctly, providing a sound, watertight seal to prevent water ingress.
2. A good RF seal between the RF gasket in the lid and the amplifier housing to prevent RF ingress/egress.
3. A good lid to housing contact for the dissipation of amplifier heat. The lid acts as a radiator when it is correctly secured, keeping the amplifier operating temperature down to within the correct parameters when installed as recommended.

3.4 Configuring the PSU

The DBC-1200 has the following power supply options:

1. Local powering is possible on RF port 3 (bypass port) using a power inserter
2. Remote powering, maximum AC power passing = 10

See page 27 for removal/installation of PSU unit.

Powering routing

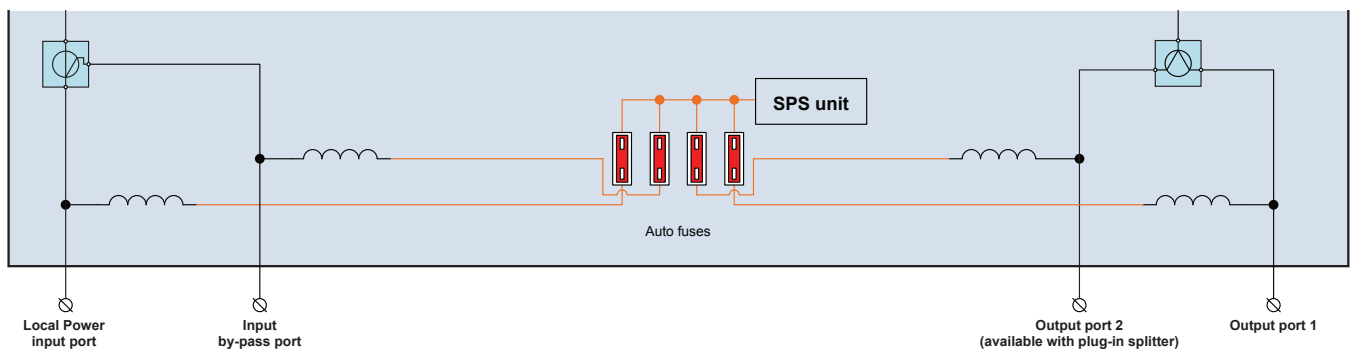

Fusing (power directors)

Referring to the network design documentation, remove any fuses not required for passing power.

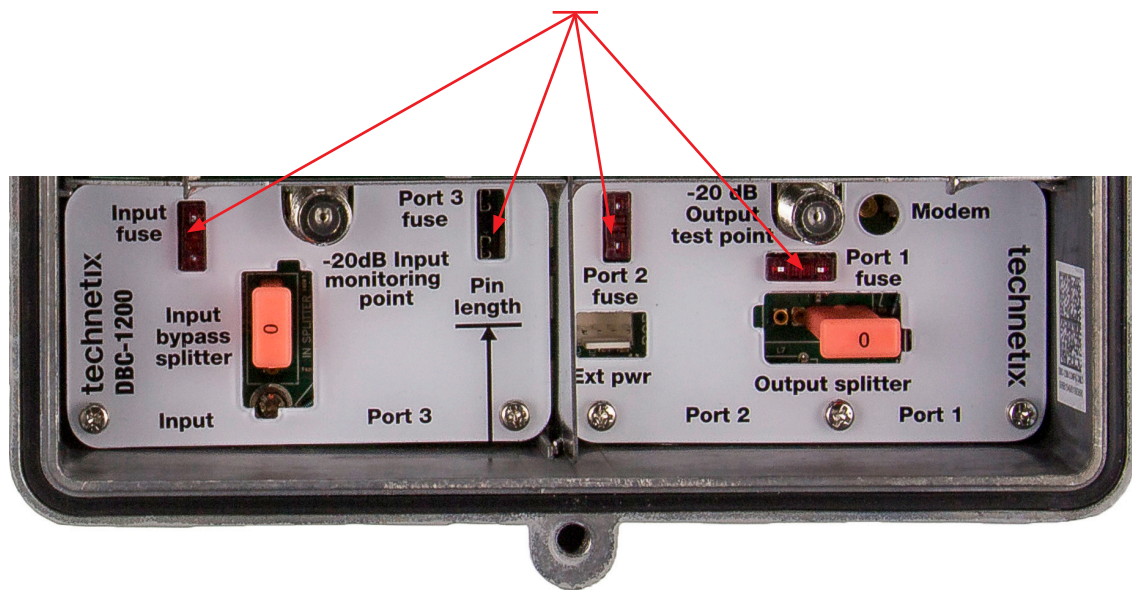

(Figure 4)

3.5 Powering up the amplifier

1. When the device is configured and once the amplifier is mounted into the network location, temporarily remove the fuses. Connect the RF cables to the relevant RF ports, and connect the earthing/grounding wire (in accordance with local electrical installation regulations) on the right hand side of the housing.



2. Use a true RMS digital voltmeter to confirm AC power is present on the incoming power port in accordance with the network design drawings. The voltage should be within the amplifier specification and the network design drawing calculation.

3. Install the fuse (power director) ensuring it is fully inserted into the fuse holder in the relevant port for incoming AC power. Check that the amplifier DBDCM module LED (DBDCM-Ax = red, DBDCM-Cx = green) and the PSU LED.

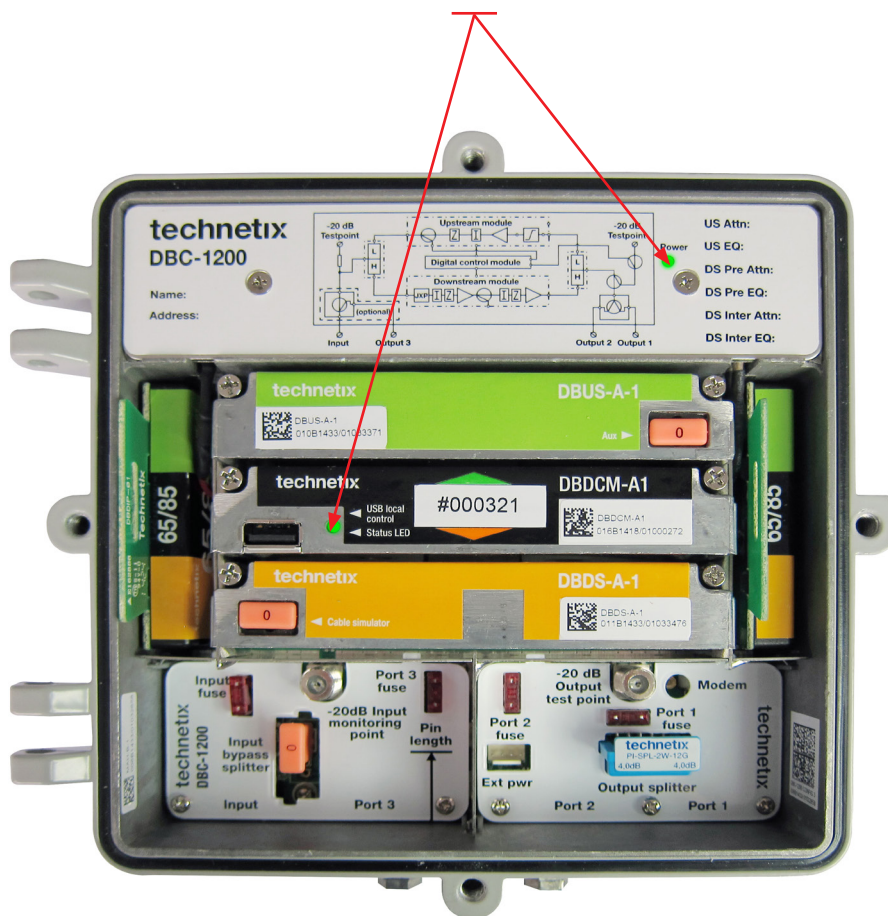

(Figure 5)

3.6 Downstream configuration

Note: a range of input splitters is available up to a value of 1.2 GHz (1.2 GHz splitter item code: 19005718)

1. Referring to the network design documentation, configure the input bypass splitter by installing a 0 pad/jumper into the top three holes of the five holes (to pass all RF into the amplifier). Alternatively, install a relevant 2-way splitter or directional coupler.

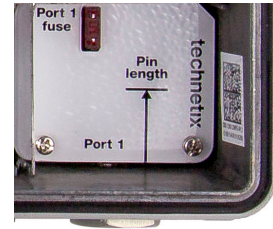

Note: bottom two holes should be exposed with 0 pad/ jumper in top three holes.

2. Ensure that the directional coupler is installed the correct way round so that the through leg is passing RF signal into the correct path as required by the network design documentation.

With the selector installed as shown, pin 5 is to the top so the through leg is to RF Port 3 and pin 5 is passing RF into the amplifier.

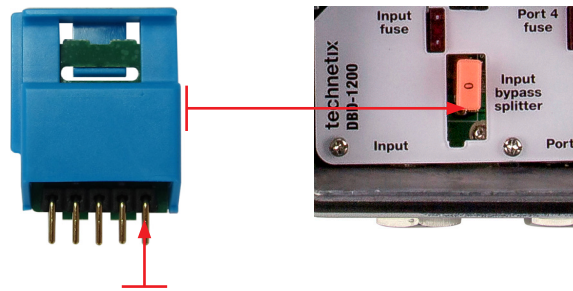

Pin 5 is the tap leg.

Output splitter selector

Referring to the network design documentation, configure the output splitter by installing a 0 pad/jumper into the right-hand three holes of the five holes (to pass all RF into Port 1) or the three left-hand holes (to pass all RF into Port 2). Alternatively, install a relevant 2-way splitter or directional coupler.

Output selector shown with a 0 pad/jumper installed into the right-hand three holes, passing all output RF into Port 1

When installing a directional coupler, ensure that it is inserted the correct way round so that the through leg is passing RF to the correct port as required by the network design documentation.

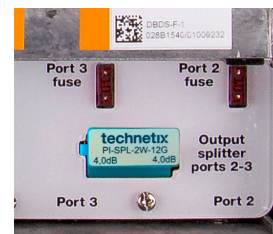
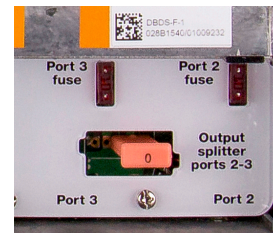

3.7 Downstream activation

Connect a spectrum analyser to the input -20 dB test point, then measure and record the RF pilot frequencies' input levels as per the design drawings.

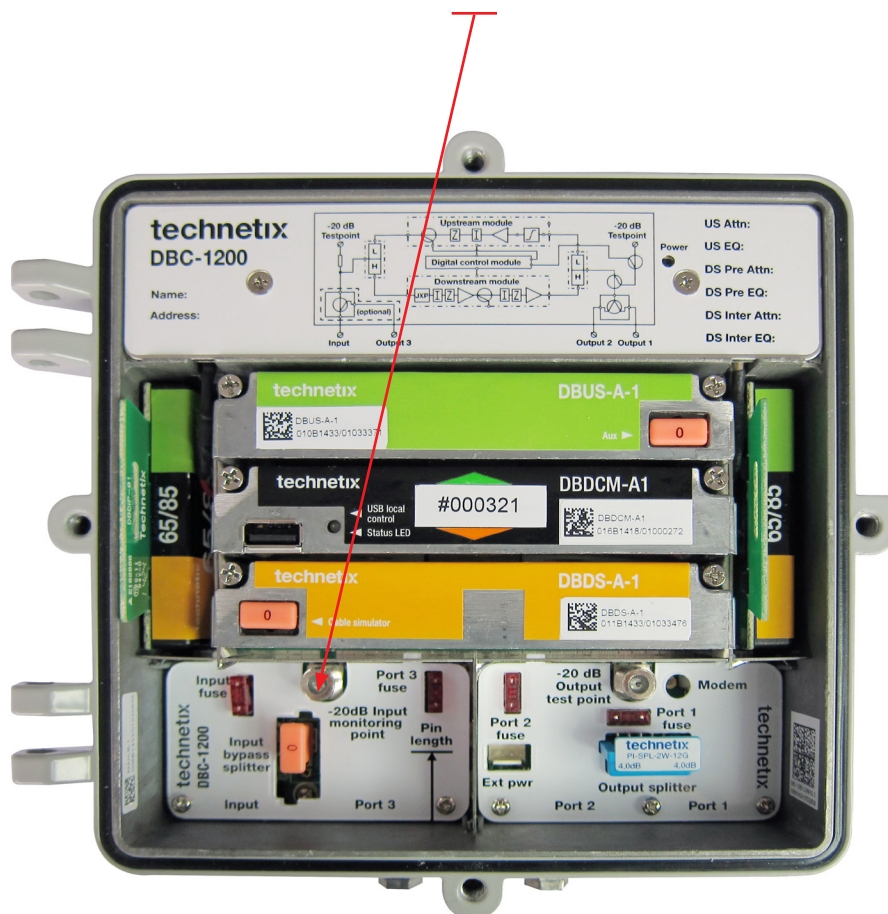

Note: ensure all amplifier ports are connected to a 75Ω terminated load so that the RF test instrument readings are correct.

Electronic setup downstream

Note: for advanced settings and configurations, please refer to the latest release of our BLL software.

Using a laptop with the Technetix BLL software installed, connect the laptop and the amplifier.

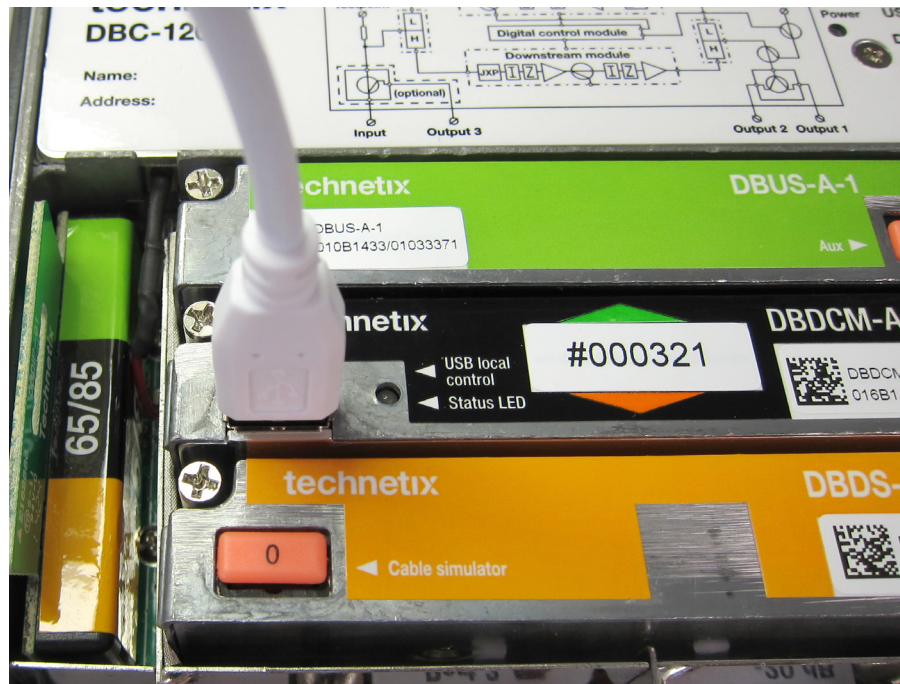



- Next, carry out the following:

Note: steps 1 to 3 can be set on the bench if the amplifier is powered up before it is deployed.

- When the USB is connected the software will autodetect the connected amplifier. This enables the BLL application to connect to the DBDCM module. Once the amplifier communication is established, the amplifier type name will appear at the top left of the application (this process is carried out automatically with the latest versions of BLL software - please specify version numbers).

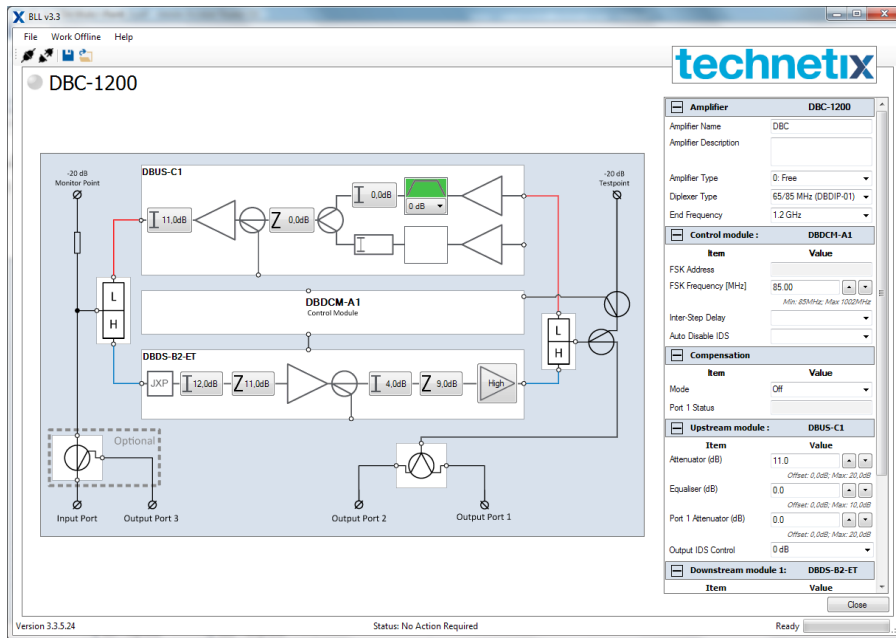

- Set the **Amplifier Type** to its respective application followed by the **Diplexer Type** and the upper equaliser hinge point - **End Frequency**.

Amplifier		DBC-1200
Amplifier Name	DBC	
Amplifier Description		
Amplifier Type	0: Free	
Diplexer Type	65/85 MHz (DBDIP-01)	
End Frequency	1.2 GHz	

Once these values are set in the application, click on 'Send to amp' to set these values electronically.

- The downstream **Inter-stage equaliser** and **Inter-stage attenuator** can be set as required by the network/system design documentation in two ways. You can set them in the amplifier schematic inter-stage tabs or in the table to the right of the application screen (see the screen shot below). Once the values are set in the application, click on **Send to amp** to set these values electronically.

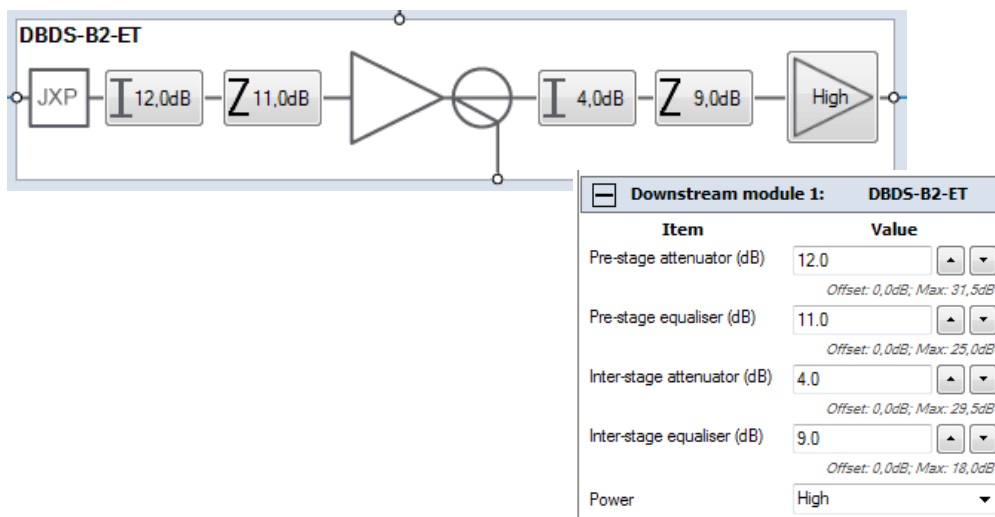

- Ensure that all RF output ports in use are connected to a 75Ω terminated load to prevent reflections affecting the RF spectrum analyser readings for commissioning levels. Connect a spectrum analyser to the -20 dB output test point. Read the pilot frequency levels and set them to the network design/system levels required by adjusting the pre-stage equaliser first to obtain the correct pilot tilt/slope value as required in the network/system design documentation. Remember, once a value is set in the **Pre-stage equaliser** field, the amplifier schematic, or the parameter view table to the right of the application screen, click on **Send to amp** to set these values electronically. Then check the tilt/slope between the pilot frequencies on the spectrum.

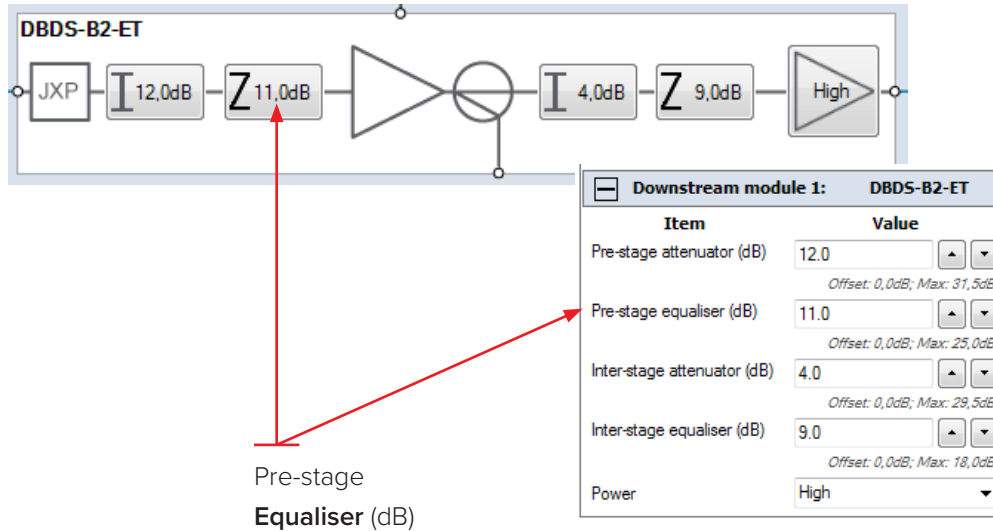

- Next set the pilot frequencies' levels by changing the **Pre-stage attenuator** values in the amplifier tab schematic or parameter view table. Remember to click on **Send to amp** after changing the values in the BLL application and check that the levels are correct on the RF spectrum analyser.

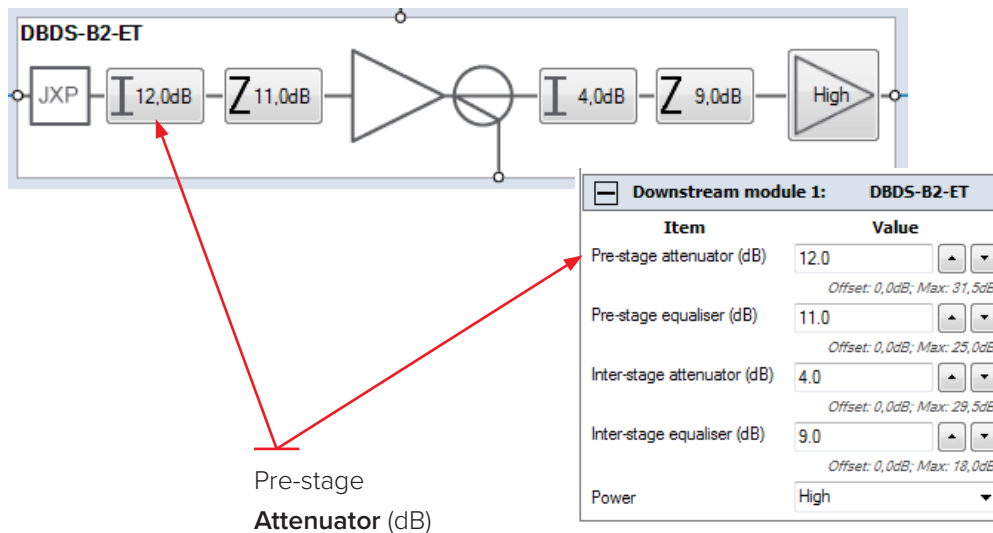

- Once the amplifier downstream/forward is commissioned, the software values can be recorded on the PSU lid label using a permanent marker pen, they can also be saved electronically.

To save the amplifier settings electronically, enter the amplifier ID number into the **Amplifier name** field as shown below.



Next, click on the **File** tab and then select on **Save backup file**. File name will be amplifier name as in the screen shot above and the date at time of saving.

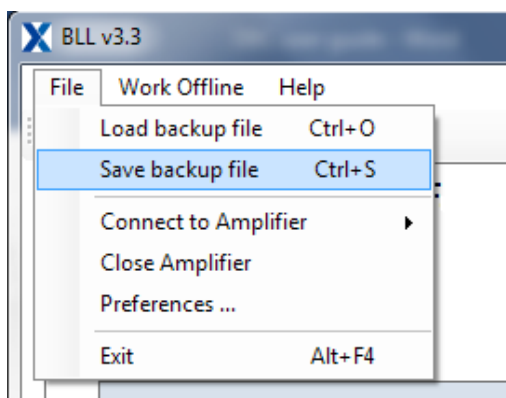

3.8 Upstream activation

Two person method

1. Connect a return path signal generator or a return path sweep system analyser to the -20 dB output test point.

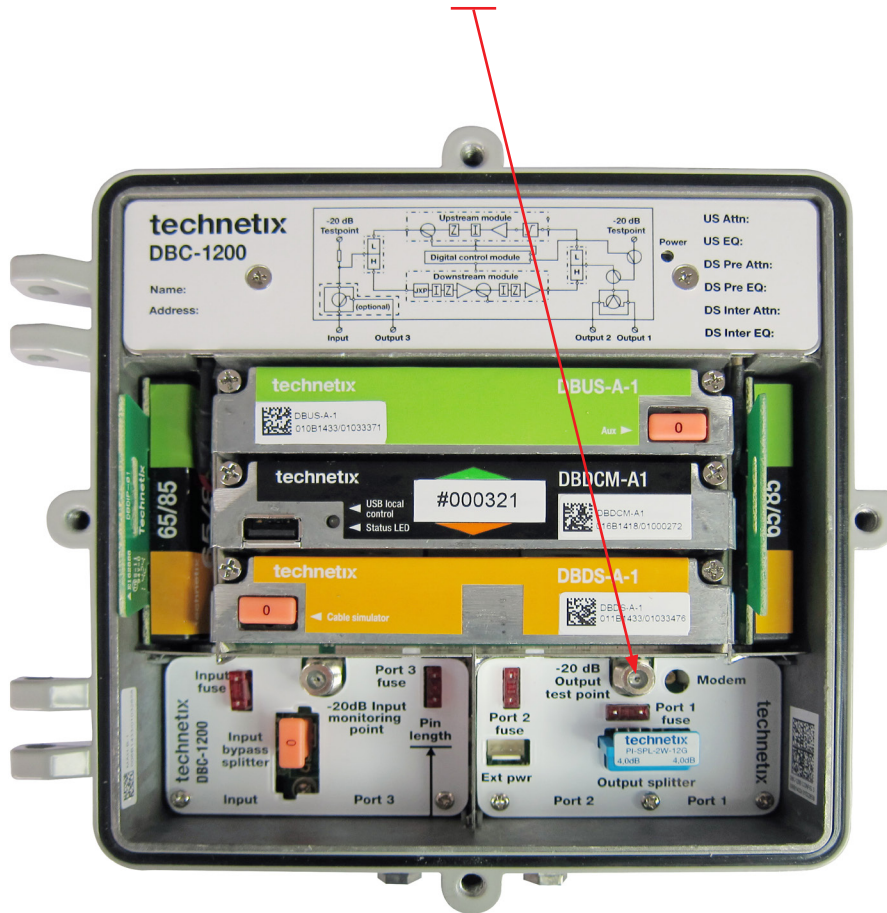

2. Set the output level of the signal generator/return path sweep system to the network return path/upstream alignment level and add +20 dB for the -20 dB test point, so that the correct level is injected into the amplifier. Use a signal generator with 2 x CW carriers at 16 and 64 MHz at a 40 dBmV output level.
3. Connect a laptop (with the BLL software installed) to the amplifier DBDCM module using a standard USB cable. Start the BLL software on the laptop.



4. Set the correct **Diplexer Type** and set **Output IDS Control** to 0 dB.

Amplifier		DBC-1200	
Amplifier Name	DBC-A02		
Amplifier Description			
Amplifier Type	0: Free		
Diplexer Type	65/85 MHz (DBDIP-01)		
End Frequency	1.2 GHz		

Upstream module :		DBUS-C1	
Item	Value		
Attenuator (dB)	11.0	Offset: 0,0dB; Max: 20,0dB	
Equaliser (dB)	0.0	Offset: 0,0dB; Max: 10,0dB	
Port 1 Attenuator (dB)	0.0	Offset: 0,0dB; Max: 20,0dB	
Output IDS Control	0 dB		

5. Using two-way communication, contact the technician at the next amplifier/node on the upstream. Their RF spectrum analyser test meter should be connected to the test point where the return path signals can be seen from a signal generator. Advise the technician at the amplifier being setup to adjust the upstream tilt so that the 2 x CW signals are at the same level.

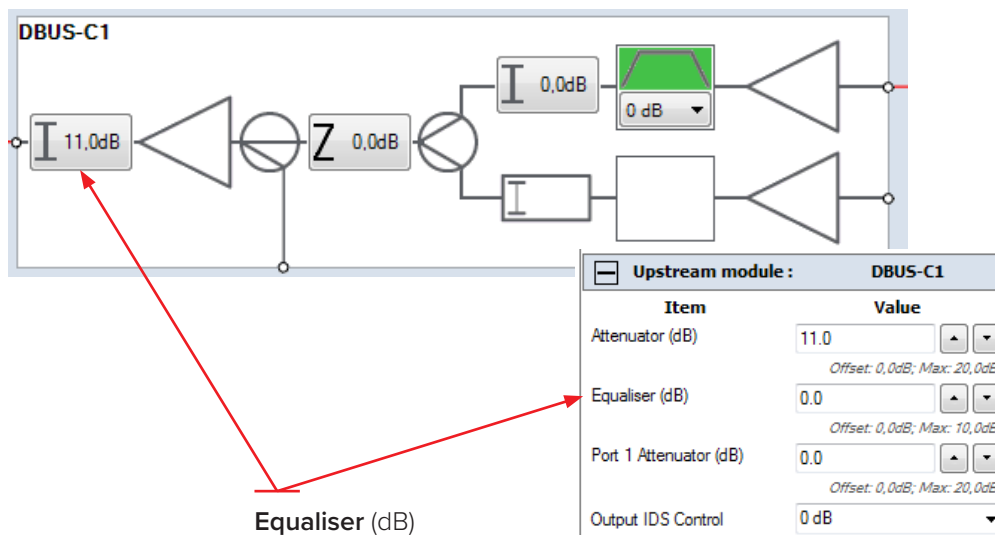

6. Next advise the attenuation level adjustment required to obtain the correct levels for upstream.

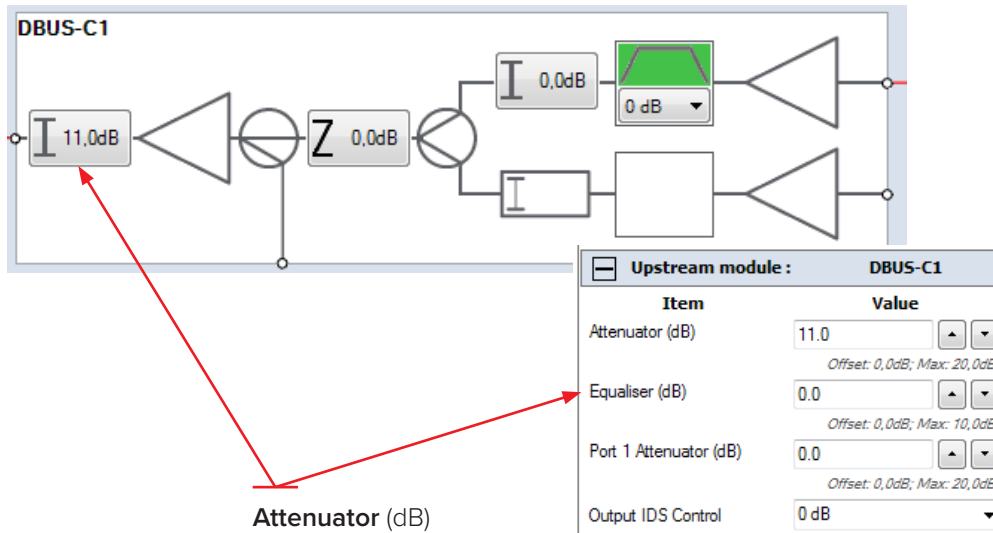

Single person method: alignment with return path sweep set up equipment

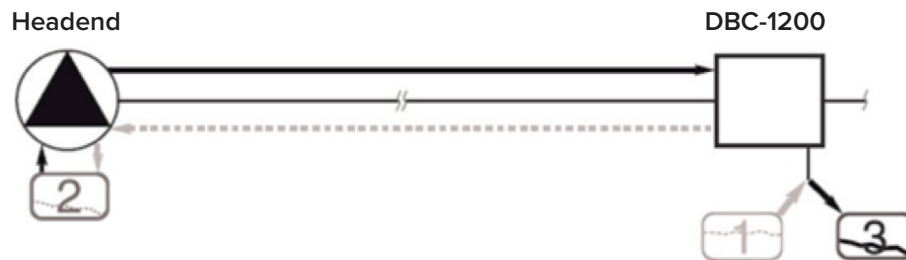

2 is a headend rack mounted sweep receiver/transmitter. This analyses the incoming sweep signal from 1 and transmits it back to 3.

1 is a handheld sweep TX unit and 3 is a handheld sweep RX. 1 and 3 are all-in-one field units.

1. Set the return path sweep generator output to the required return path/upstream alignment level plus 20 dBmV to overcome the -20 dB test point. Connect the test equipment return sweep output to the -20 dB output test point and the return sweep RF forward data to the -20 dB input monitoring test point. Using the BLL software, adjust the amplifier upstream tilt followed by the attenuation to obtain a flat sweep response at the correct level for the upstream network design.

2. Once the amplifier upstream/return path is commissioned, software values can be recorded on the PSU lid label using a permanent marker pen. They can also be saved electronically.
3. To save the amplifier settings electronically, enter the amplifier ID number into the **Amplifier name** field as shown below. Use the same name as for the upstream activation.

Amplifier		DBC-1200
Amplifier Name	<input type="text" value="DBC-A02"/>	
Amplifier Description	<input type="text"/>	
Amplifier Type	0: Free	
Diplexer Type	65/85 MHz (DBDIP-01)	
End Frequency	1.2 GHz	

4. Next click on the **Tools** tab and then click on **Save current state to file**. File name will be the amplifier name as in the screen shot and the date at time of saving.

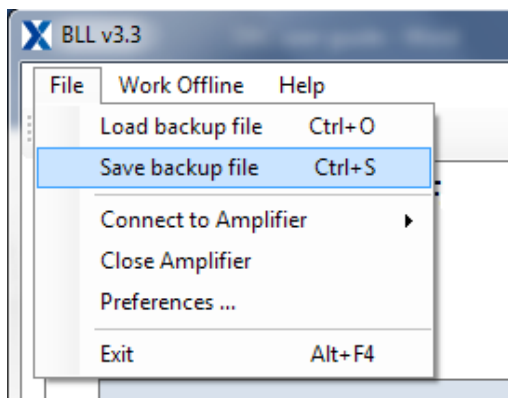

Chapter 4: Maintenance

4.1 PSU replacement

Note: ensure line power is disconnected before starting PSU replacement.

1. Remove the 2 x PSU cover plate crosshead screws, then the PSU cover plate

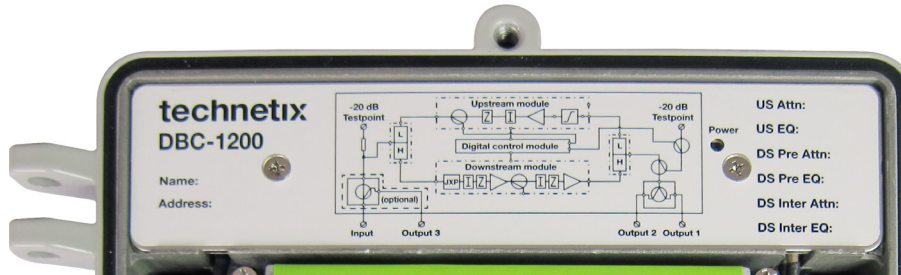

2. Unscrew both PSU holding screws. Remove the PSU by lifting it carefully and sliding the grounding pass-through PSU leads' clips out of their slots.

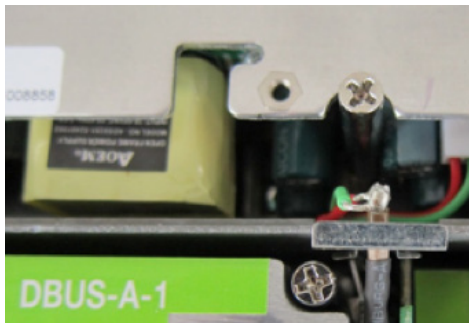

3. Use a screwdriver to release the PSU electrical connectors' securing clips and unplug the leads

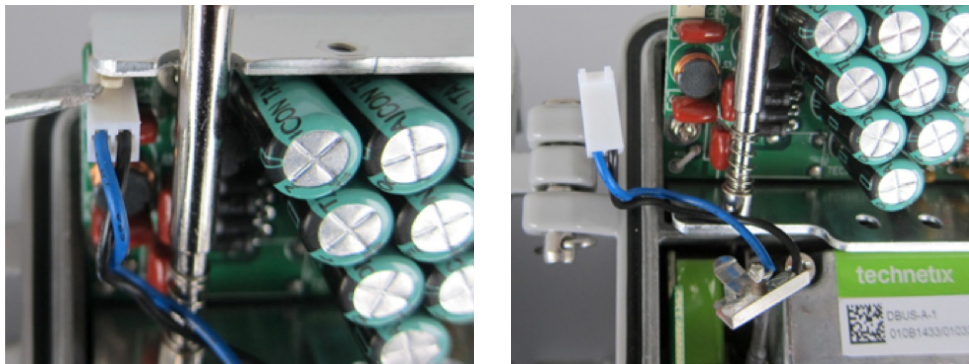

4. Remove the PSU from the DBC-1200 housing.



5. Installation is the reverse of removal:
 - a. Connect the electrical connectors to the PSU.
 - b. Place the PSU into the housing and secure the PSU with the 2 holding screws.
 - c. Slide the grounding pass-through PSU leads' clips into the housing slots, ensuring they are seated down to the bottom of the slots.

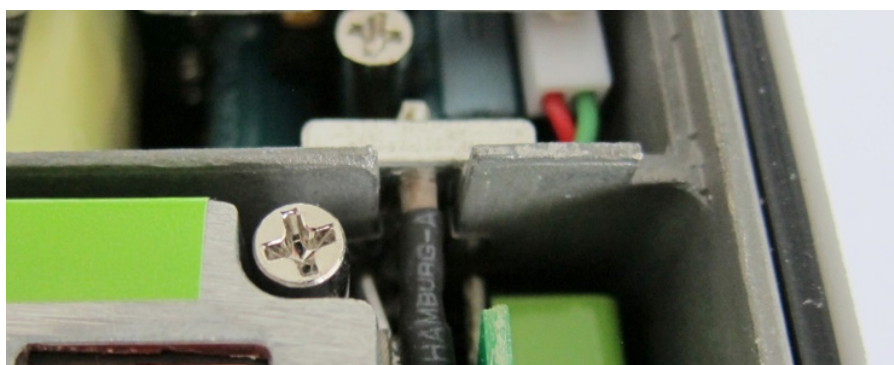

d. Replace the PSU cover and secure it with 2 x crosshead screws.

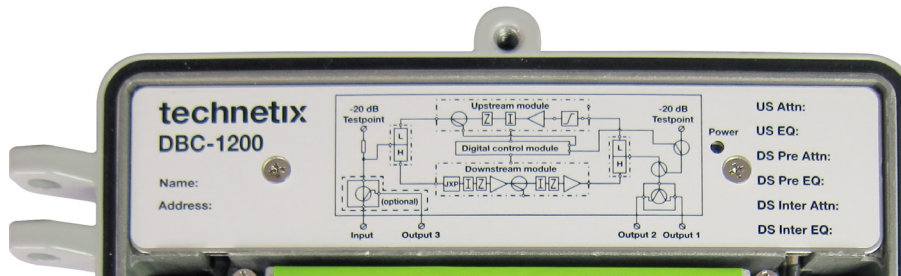

e. Apply power and ensure that the PSU green LED is on.

4.2 Amplifier module replacement

The following modules are hot swappable, so can be replaced with the unit powered up.

Note: the modules should be pulled out vertically.

Before changing or swapping the modules or diplexers, connect the amplifier to your laptop with the USB cable and upload and save the configuration of the amplifier onto your laptop. When the module(s) have been changed, re-send the saved configuration file to the amplifier.

Downstream



1. Remove a module, unscrew both screws and then grip the ends of the module applying a rocking motion whilst pulling the module at the same time.
2. To install the module, place it into the downstream slot and push firmly and squarely down onto the unit until it is fully seated. Secure it by tightening the screws to a torque value of 1.5 Nm.

Upstream



1. To remove a module, unscrew both screws and then grip the ends of the module applying a rocking motion whilst pulling the module at the same time.
2. To install the module, place it into the upstream slot and push firmly and squarely down onto the unit until it is fully seated. Secure it by tightening the screws to a torque value of 1.5 Nm.

Digital control



1. To remove a module, unscrew both screws and then grip the ends of the module applying a rocking motion whilst pulling the module at the same time.
2. To install the module, place it into the upstream slot and push firmly and squarely down onto the unit until it is fully seated. Secure it by tightening the screws to a torque value of 1.5 Nm.

Diplex filters

1. To remove a diplex filter: grip the centre of the PCB with a pair of linesman's pliers and gently pull out the diplex filter vertically, avoiding risk of damage to the connectors.

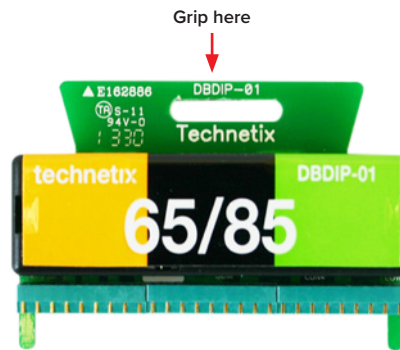

2. To install a diplex filter: guide the filter guide pegs onto the slots in the amplifier circuit board and then push down evenly on the diplex filter until it is fully seated into the amplifier. Take care to avoid damaging the connectors.

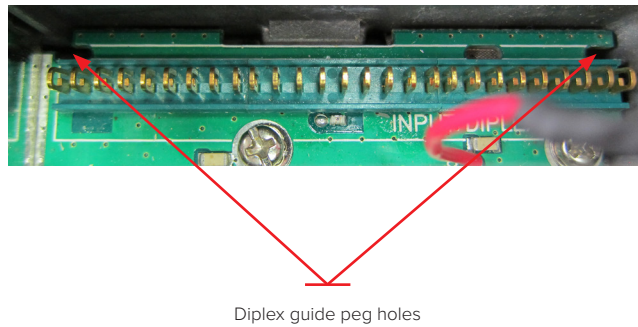
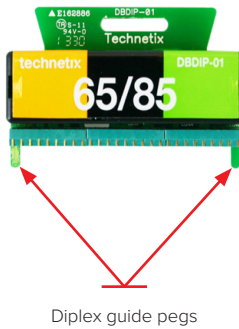

Chapter 5: Optical node 1x1

5.1 General installation

The inner fibres are pre-installed inside the tray including the optional WDM's and are connected to the SC/APC barrels.

Powering the node can be done through the optional by-pass ports inside the amplifier or the input ports (as this is unused in optical configuration), there is also an option for local 230VAC powering. The external fibres are brought inside the node through the 5/8" opening in the lid which is covered by a blind-stop as per figure 6.

Guide the external fibre through the fibre tray using the outer guide lines as much as possible (as these have a wider bending radius for thicker pig-tails).

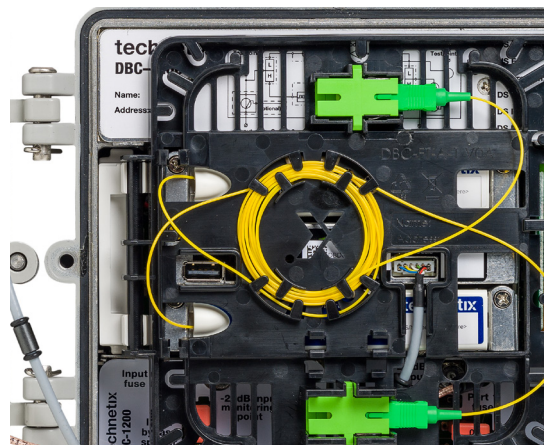

(Figure 6)

5.2 Downstream connection

The DBRX-A-1 can receive wavelengths from 1100 to 1610nm from the headend.



Connect the downstream fibre to an optical power meter and check that the level falls within the operating window of the optical AGC, from -7dBm to +1dBm. Operating in this range guarantees maximum available output power.

When the level is within range, connect the fibre to the WDM or the downstream receiver and the downstream feed will become active. The more tilt applied in the range up to 12dB. Use attenuators to limit the output power to the required input level of the product minus the cable loss.

5.3 Upstream connection

The DBTX-A-1 is a dual module and has 2 upstream laser board slots. In the case of a DBD or DBE you can use the 2nd slot for a secondary laser or, when configured as a hybrid mixture, you can use a combining board (DBLB-CB-1) to combine the RF from the secondary downstream feed over a single laser.

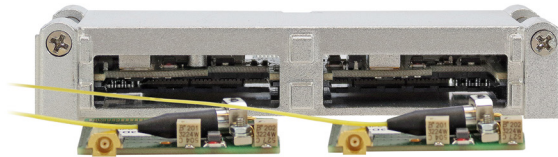

Connect the upstream laser to the pigtail or WDM module.

Remove the cover from the transmitter module so that the slots are visible.

A test point is located on all laser boards, this will align your Optical Modulation Index (OMI) to a satisfactory level. Depending on the number of upstream channels, you can theoretically divide the 100% OMI available over the respective channels. The higher the OMI percentage, the better your uplink. The upstream RF level can be measured by using an MCX to F-female adapter (DBLB-TP-CON) connected to a spectrum analyzer.

DBLB testpoint (dBmV)	DBLB testpoint (dBμV)	OMI (%)
20	80	10
19	79	8.9
18	78	7.9
17	77	7.1
16	76	6.3
15	75	5.6
14	74	5.0
13	73	4.5
12	72	4.0
11	71	3.5
10	70	3.2
9	69	2.8
8	68	2.5
7	67	2.2
6	66	2.0
5	65	1.8
4	64	1.6
3	63	1.4
2	62	1.3
1	61	1.1
0	60	1

5.4 CWDM Applications

The DBx comes with tube style and cassette style CWDM modules enabling single fibre applications. They are available in 2, 4 & 8 channels. The common port is used to connect the external fibre; all other connections are made to the dedicated wavelengths of the CWDM module.

Mini CWDM
4 and 8 channel
(for use in DBE series fibrenode)



Tube style CWDM filter
2 channel
(for use in DBC and DBD series fibrenode)



Cassette style CWDM filter
2, 4 and 8 channel
(for use in headend LGX-style cassettes)



5.5 Software settings

When opening the Basic LoCon Laptop (BLL) software the connected node will be shown on the screen as a block diagram. The upstream section contains:

1. Lasers installed
2. Wavelengths
3. Output powers

Attenuators are used to attenuate the RF level for the individual ports to reach a satisfactory level to achieve the ideal OMI %. This can be done by using the block diagram or by using the menu on the right. The IDS switches are available to use when ingress occurs and you need to troubleshoot into the right segment.

The downstream module section shows the optical received power. The attenuators can control the RF gain from the node. The equalizers must be set according to the cable type and length, leaving the node for further application. The RF end stage is controllable and can be set to high or low power mode. When maximum output power is not required it can be configured to low power, saving 2 watts power consumption.

Upstream module : DBTX-A1	
Item	Value
Laser 1 Type	DFB 1310nm 3dBm
Laser 1 Status	0 mA
Laser 2 Type	DFB 1310nm 3dBm
Laser 2 Status	0 mA
Port 1 Attenuator (dB)	6.5
	<i>Offset: 0,0dB; Max: 25,5dB</i>
Port 2 Attenuator (dB)	3.5
	<i>Offset: 0,0dB; Max: 25,5dB</i>
Output IDS 1 Control	0 dB
Output IDS 2 Control	0 dB

Downstream module 1: DBRX-A1	
Item	Value
Receiver power	0,0 dBm
Inter-stage attenuator (dB)	4,0
	<i>Offset: 0,0dB; Max: 31,5dB</i>
Inter-stage equaliser (dB)	9,0
	<i>Offset: 0,0dB; Max: 15,5dB</i>
Power	High



5.6 Upgrading a RF amplifier into an optical node

In the following section, we are going to demonstrate the upgrade of an amplifier to optical fibre node in less than 10 minutes:

01



Remove RF modules and input diplex filter. These modules can be reused in other amplifiers. If an input splitter/tap is installed, this can be removed at this time as well.

Note: all procedures can be executed while the amplifier is powered up.

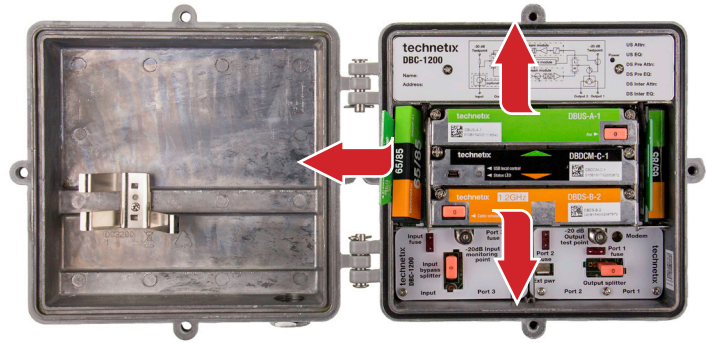

02



Insert the optical receiver module in the bottom slot (replacing the RF forward amplifier) and the upstream transmitter into the top slot (replacing the return amplifier).

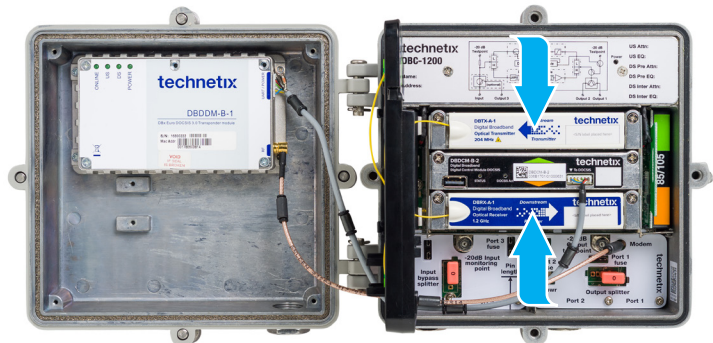

03



Install the fibre tray in the position of the input diplex filter and secure it with a screw.

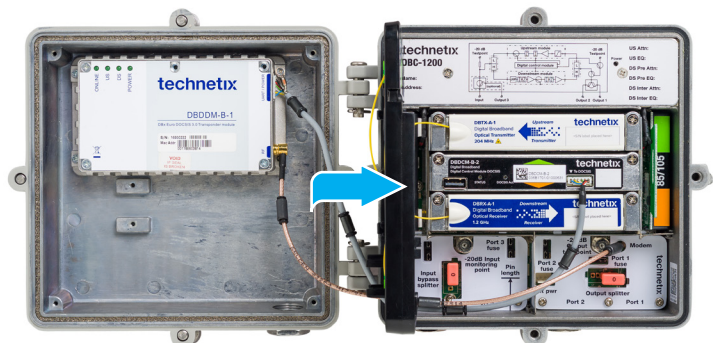

04



The incoming fibre needs to be inserted into the amplifier through the lid port (5/8th thread). Ensure the cable is securely fitted inside clips.

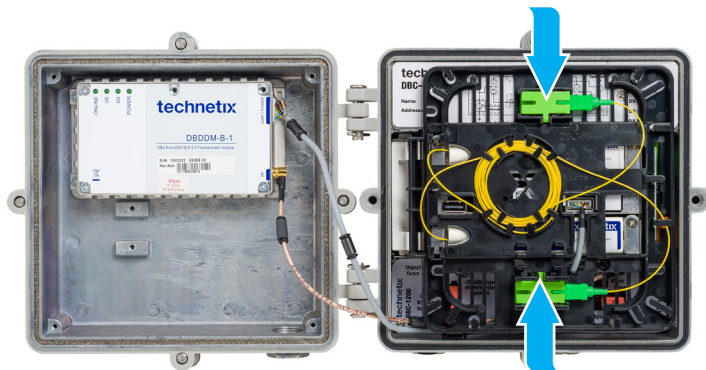

05



Connect USB cable to digital control module and configure settings using the DBx software. All settings for the optical module can be executed with the same configuration as a RF amplifier

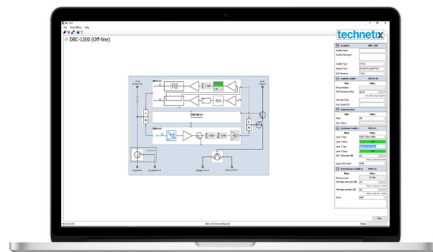

06



Close DBx product, ensuring all bolts are secured correctly. The upgrade of the amplifier to an optical fibre node is now completed.

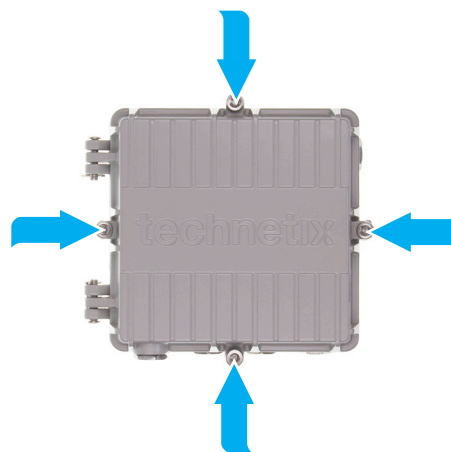



5.7 Optical modules

The platform has the following main modules for a default node applications:

DBRX-A-1	1.2GHz optical receiver module
DBTX-A-1	204MHz dual optical transmitter module
DBLB-31-3D-1	Plug-in laser board 1310nm 3dBm analogue
DBLB-55-3D-1	Plug-in laser board 1550nm 3dBm analogue
DBLB-cxx-3D-1	Plug-in laser board CWDM wavelength selection 3dBm analogue
DBLB-CB-1	Combining board for hybrid RF/node configuration which combines upstream over signal laser.
DBLB-BP-1	Terminating board in case of a single upstream in a DBC for the 2nd slot in DBTX-A-1
DBLB-TP-CON	MCX to F-Female adapter for measuring upstream RF level

Other output power options are available, please contact your local sales representative for further information. details available technetix.com



© Copyright 2017 Technetix Group Limited. All rights reserved.

This document is for information only. Features and specifications are subject to change without notice. Technetix, the Technetix logo, Ingress Safe, Modem Safe and certain other marks and logos are trade marks or registered trade marks of Technetix Group Limited in the UK and certain other countries. Other brand and company names are trade marks of their respective owners. Technetix protects its technology and designs by registering patents, trade marks and designs in Europe and certain other countries.

Rev1.DBC_01_0217

technetix